



ACA and ACZ series

- high weighing accuracy
- very good indication readability (LCD 18mm)
- indication backlight
- automatic internal calibration (ACA)
- RS232C and USB interface for printer, computer, label printer and barcode reader



Laboratory balances ACA and ACZ series are designed for use in laboratories, pharmacies, jewelry and research institutes where high accuracy of measurement is required.

 external calibration	 products database	 unit selection	 animals weighing
 internal calibration	 date/time	 weighing speed selection	 density measurement
 GLP compatibility	 printout config.	 threshold/selection	 force measurement
	 pieces counting	 max weight	 recipe
	 percentage	 min weight	 statistics
	 summation	 Alibi memory	

Options on demand



Under hook weighing



Protective cover



Glass draft shield



ACA hydro set

hook for hanging weighed object

protective cover to secure pan

glass draft shield

ACA hydro set to measure density of liquids and solids

USB_A (for USB flash drive or AXIS printer), LAN or Wi-Fi to work with computer

barcode reader interface (RS232C+supply)

computer software : Statistics ^{freeware}, Communication ^{freeware} - saving to file, ProCell - export to Excel

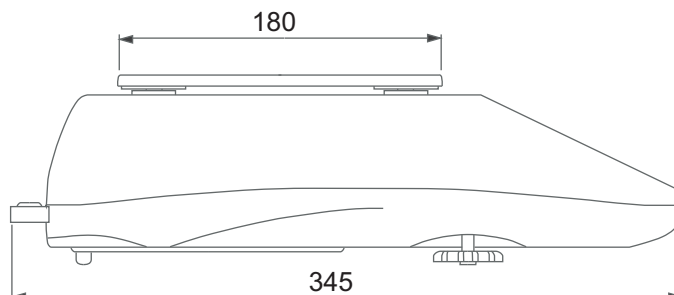
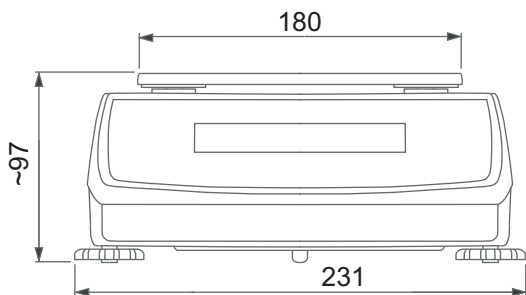
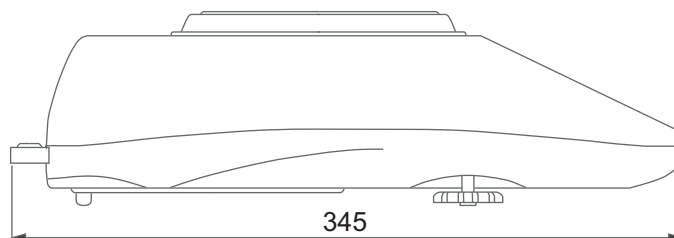
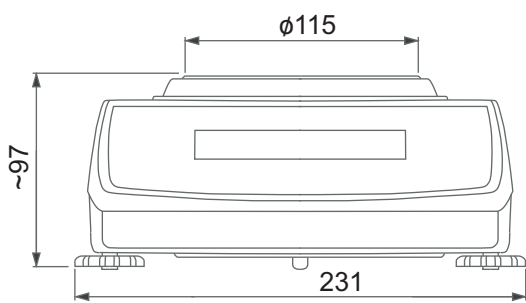

Balances with verification option

M

Technical data





















Balances with int. calib.	ACA220	ACA320	ACA520	ACA620	ACA820	ACA1000	ACA2200	ACA3200	ACA4200	ACA6200
Balances without int. calib.	ACZ220	ACZ320	ACZ520	ACZ620	ACZ820	ACZ1000	ACZ2200	ACZ3200	ACZ4200	ACZ6200
Capacity (Max)	220g	320g	520g	620g	820g	1000g	2200g	3200g	4200g	6200g
Reading unit (d)	0,001g	0,001g	0,001g	0,001g	0,001g	0,001g	0,01g	0,01g	0,01g	0,01g
Verification unit (e)	0,01g	0,01g	0,01g	0,01g	0,01g	0,01g	0,1g	0,1g	0,1g	0,1g
Tare range	-220g	-320g	-520g	-620g	-820g	-1000g	-2200g	-3200g	-4200g	-6200g
Accuracy class	II									
Repeatability						0,001g		0,01g		0,02g
Linearity						± 0,002g		± 0,02g		± 0,02g
Working temperature	+10 ÷ +40°C									
Weighing time	<3s									
Pan size	115mm					180x180mm				
Display	LCD digits height 18mm									
Dimensions (with legs)	231x345x97mm									
Interfaces	RS232, USB-B options: USB_A, LAN or Wi-Fi									
Units	mg, g, kg, ct, lb, oz, ozt, gr, dwt									
Power supply	~230V 50Hz 9VA / =12V 1,2A									
Balance weight	4kg									
Recommended std. of mass	F2 200g		F1 500g		E2 1000g		F2 2000g		F1 5000g	

ACA/G and ACZ/G series

- high weighing accuracy
- very good indication readability
- indication backlight
- automatic internal calibration (ACA)
- RS232C, USB-B and USB-A interfaces for printer, computer, label printer, barcode reader and USB flash drive (pendrive)



Laboratory balances ACA/G and ACZ/G series are designed for use in laboratories, pharmacies, jewelry and research institutes where high accuracy of measurement is required.

 external calibration	 products and users database	 unit selection	 animals weighing
 internal calibration	 measurements database	 multilanguage	 density measurement
 GLP compatibility	 date/time	 weighing speed selection	 force measurement
	 printout config.	 threshold/selection	 recipe
	 pieces counting	 max weight	 statistics
	 percentage	 min weight	
	 summation	 alibi memory	

Options on demand



Under hook weighing

Protective cover

Glass draft shield

ACA hydro set

- hook for hanging weighed object
- protective cover to secure pan
- glass draft shield
- ACA hydro set to measure density of liquids and solids
- LAN or Wi-Fi to work with computer
- barcode reader interface (RS232C+supply)
- computer software : Statistics **freeware** , Communication **freeware** - saving to file, ProCell - export to Excel

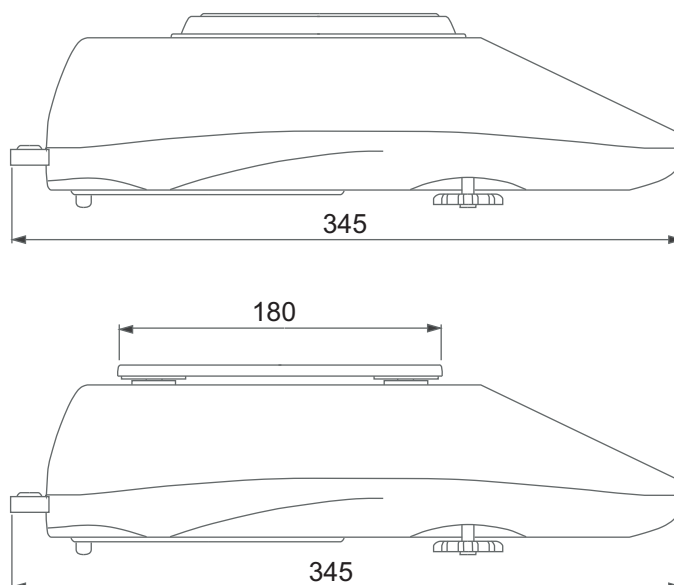
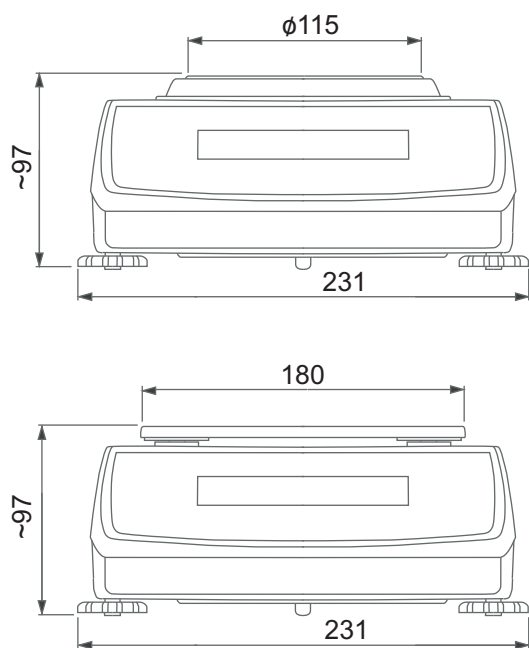

Balances with verification option **M**

Technical data

Balances with int. calib.	ACA220G	ACA320G	ACA520G	ACA620G	ACA820G	ACA1000G	ACA2200G	ACA3200G	ACA4200G	ACA6200G
Balances without int. calib.	ACZ220G	ACZ320G	ACZ520G	ACZ620G	ACZ820G	ACZ1000G	ACZ2200G	ACZ3200G	ACZ4200G	ACZ6200G
Capacity (Max)	220g	320g	520g	620g	820g	1000g	2200g	3200g	4200g	6200g
Reading unit (d)	0,001g	0,001g	0,001g	0,001g	0,001g	0,001g	0,01g	0,01g	0,01g	0,01g
Verification unit (e)	0,01g	0,01g	0,01g	0,01g	0,01g	0,01g	0,1g	0,1g	0,1g	0,1g
Tare range	-220g	-320g	-520g	-620g	-820g	-1000g	-2200g	-3200g	-4200g	-6200g
Accuracy class	II									
Repeatability	0,001g					0,01g			0,02g	
Linearity	± 0,002g					± 0,02g			± 0,02g	
Working temperature	+10 ÷ +40°C									
Weighing time	<3s									
Pan size	115mm					180x180mm				
Display	graphical 110x35mm									
Dimensions (with legs)	231x345x97mm									
Interfaces	RS232, USB-B, USB_A options: LAN or Wi-Fi									
Units	mg, g, kg, ct, lb, oz, ozt, gr, dwt									
Power supply	~230V 50Hz 9VA / =12V 1,2A									
Balance weight	4kg									
Recommended std. of mass	F2 200g		F1 500g			E2 1000g		F2 2000g		F1 5000g